



## Features & Application

- ◆ High lighting efficiency
- ◆ Optimized for uniform effects
- ◆ Roadway Lighting
- ◆ Glare Free
- ◆ Extremely luminous flux
- ◆ Soft wide beam with good illuminance uniformity
- ◆ Easy fixing system to the PCB
- ◆ Complying with UL94 Specifications
- ◆ UV protected

## Table of Contents

- ◆ General information & Product Nomenclature.....P.2
- ◆ Material specification .....P.3
- ◆ Optical specification .....P.3
- ◆ Mechanical specification .....P.4

## GENERAL INFORMATION

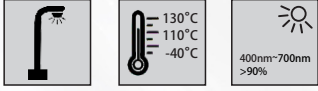

- ◆ Type II Lens For Street Light Application.
- ◆ Operating Temperature range  $-40^{\circ}\text{C} \sim +110^{\circ}\text{C}$  (upper limit  $+130^{\circ}\text{C}$ )
- ◆ Storage Temperature range  $-40^{\circ}\text{C} \sim +110^{\circ}\text{C}$  (upper limit  $+130^{\circ}\text{C}$ )
- ◆ Average transmittance in visible spectrum  $400\text{nm} \sim 700\text{nm} > 90\%$

## PRODUCT NOMENCLATURE

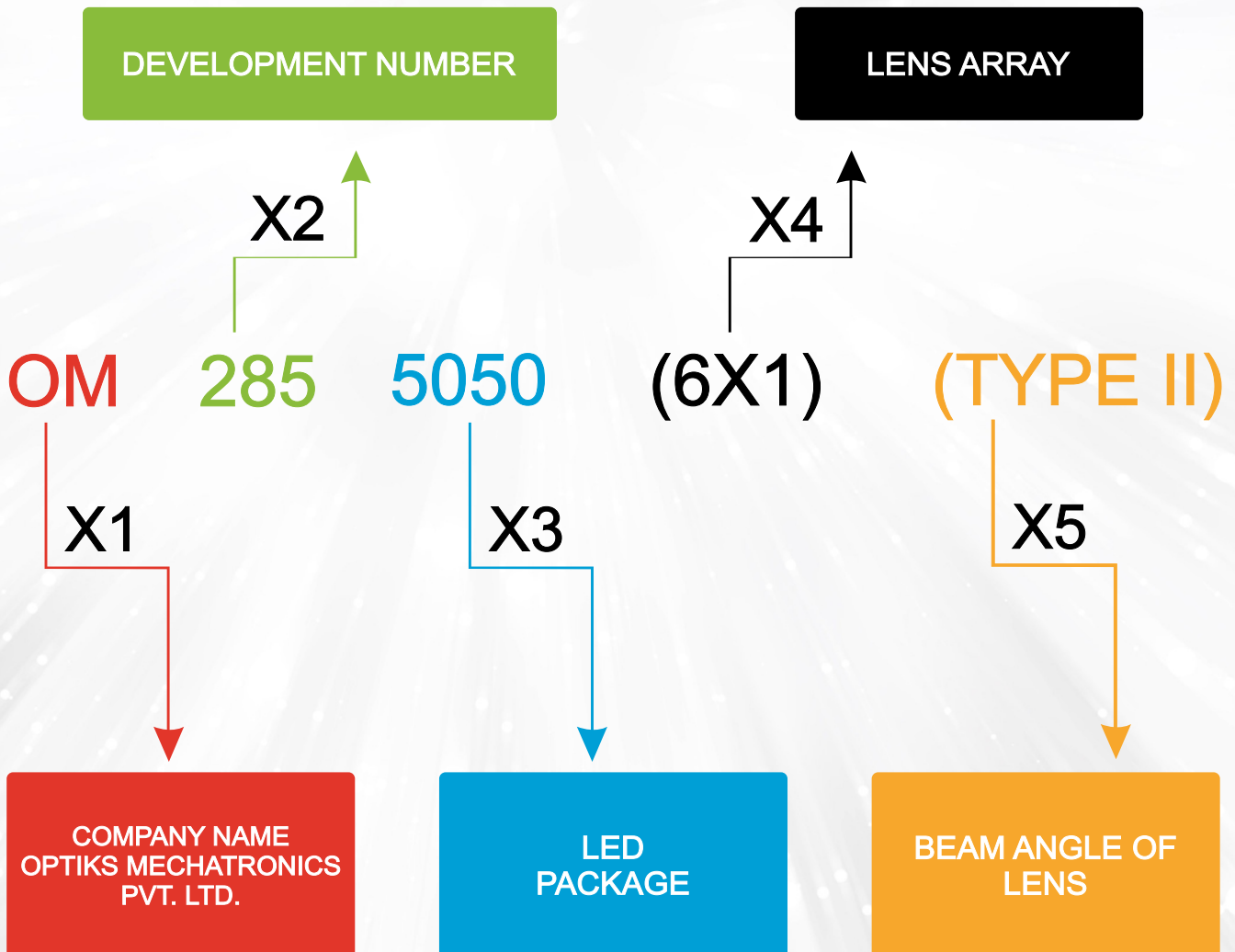

## MATERIAL SPECIFICATION



- ◆ Lens Material : Optical Grade PC (Bayer 2407)
- ◆ Luminous transmittance : 89 to 90% (ISO 13468-2/ASTM D1003)
- ◆ Refractive index : 1.584 (ISO 489/ASTM D542)
- ◆ Flammability : HB/V-0 (UI94)
- ◆ Colour : Clear

## OPTICAL SPECIFICATION

Note: (1) All the results of analysis are based on 0 degrees of elevation.  
(1) Tolerance:  $\pm 10\%$ .

### Beam Angle

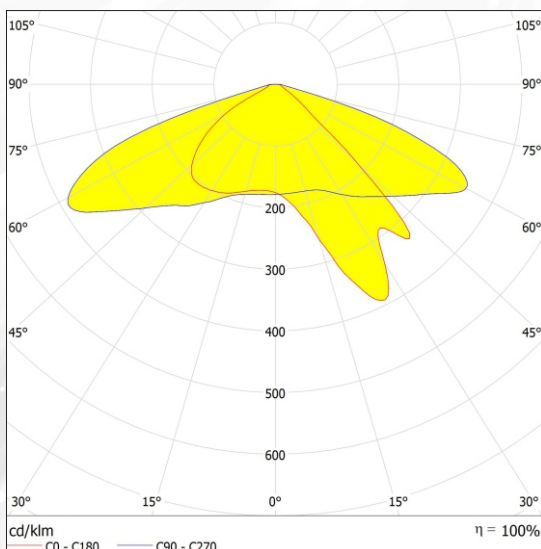

### Beam Pattern

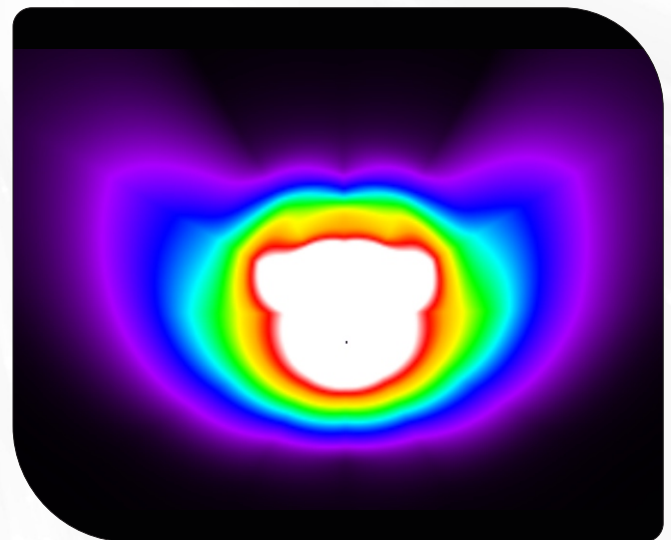

## MECHANICAL SPECIFICATION

### FASTENING

Glue

☑ Screw

Tape

☑ Fixing-ring

☑ Frame

Note:

1. Unit measurement: mm
2. General tolerance:  $\pm 0.2\text{mm}$
3. Protruding of the gate from the side surface: less than 0.3mm

### LENS DIMENSION

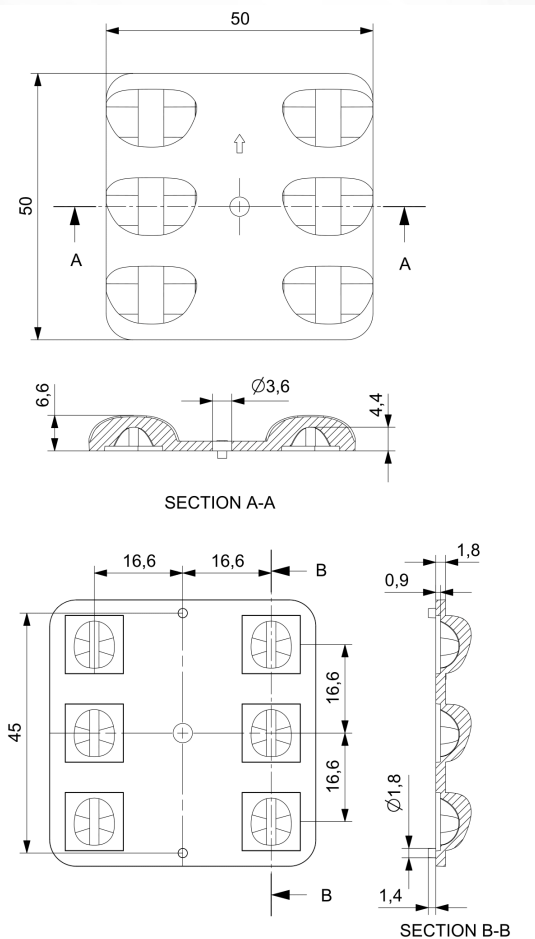

### LED+LENS ASSEMBLY INSTRUCTION

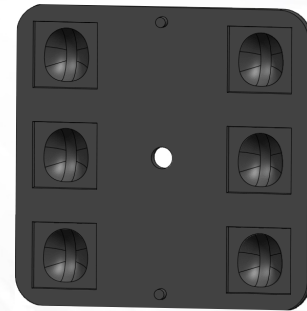
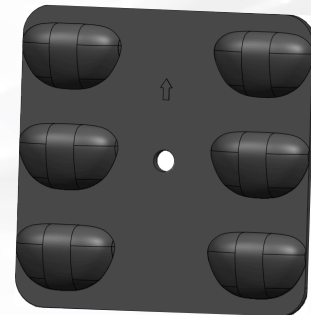

### USAGE AND MAINTENANCE



1. If necessary, clean lenses with mild soap, water and soft cloth.
2. Never use any commercial cleaning solvents on lenses, like alcohol.
3. Please handle or install lenses with wearing gloves, skin oils may damage lens or its optical characteristic.