

OM602-5050-1x1-60°



LENS IMAGE

Features and Applications :

- High lighting efficiency
- Optimized for uniform effects
- High-Bay Lighting
- Warehouse Lighting
- Industrial Lighting
- Soft wide beam with good illuminance uniformity
- Easy fixing system to the PCB
- Complying with UL94 Specifications
- UV Resistant

General Information :

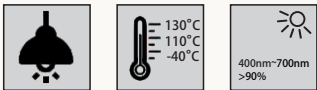

- Type V Lens for High-Bay Light Application.
- Operating Temperature range $-40^{\circ}\text{C} \sim +110^{\circ}\text{C}$ (upper limit $+130^{\circ}\text{C}$)
- Average transmittance in visible spectrum $400\text{nm} \sim 700\text{nm} > 90\%$

Material Specification :



- Lens Material: Optical Grade PC Covestro (Makrolon 2407)
- Luminous Transmittance: 89 to 90% (ISO 13468-2/ASTM D1003)
- Refractive Index: 1.584 (ISO 489/ASTM D542)
- Flammability : HB/V-2 (UI 94)
- Colour : Clear

Optical Specification :

NOTE :

1. All the results of analysis are based on 0 degree of elevation.
2. Tolerance : $\pm 5\%$

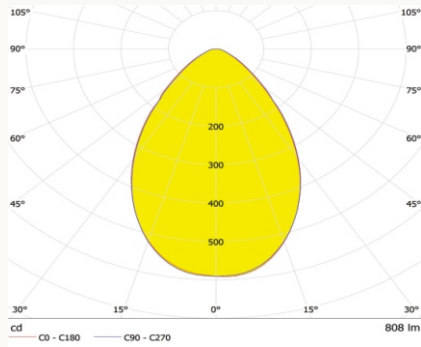

BEAM ANGLE

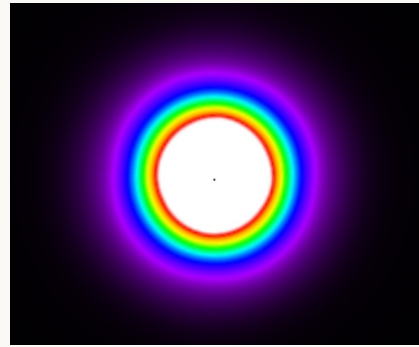

BEAM PATTERN

Mechanical Specification :

NOTE :

1. Unit Measurement : mm
2. General Tolerance : $\pm 0.2\text{mm}$
3. Protruding of the gate from the side surface : less than 0.3mm

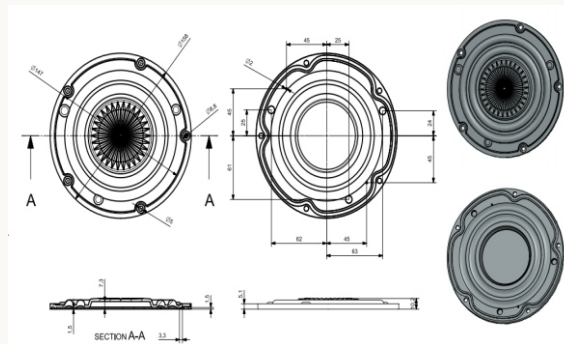

LENS DIMENSION

FASTENING

GLUE

SCREW

TAPE

FIXING-RATE

FRAME

USAGE & MAINTENANCE

1. If necessary, clean lenses with mild soap, water and soft cloth.
2. Never use any commercial cleaning solvents on lenses, like alcohol.
3. Please handle or install lenses with wearing gloves, skin oils may damage lens or its optical characteristic.